

1 RAKE FLASHING
SCALE: 1/4"=1'-0"

6 ROOF RAKE
SCALE: 1/4"=1'-0"

11 MOBILE LINE ROOF CAP
SCALE: 1/4"=1'-0"

19 INT. DOOR HEAD
SCALE: 1/4"=1'-0"

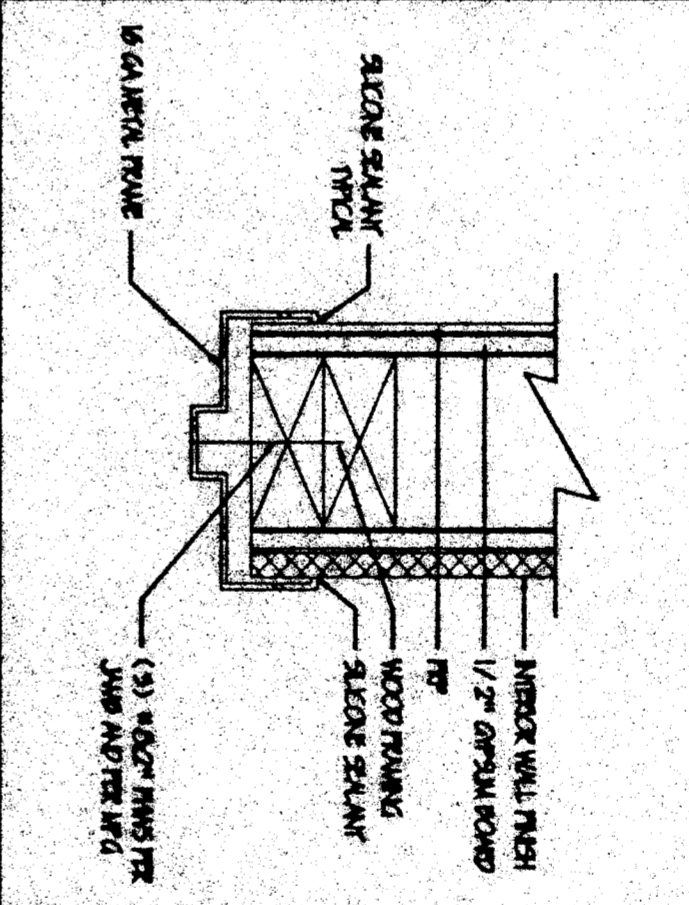
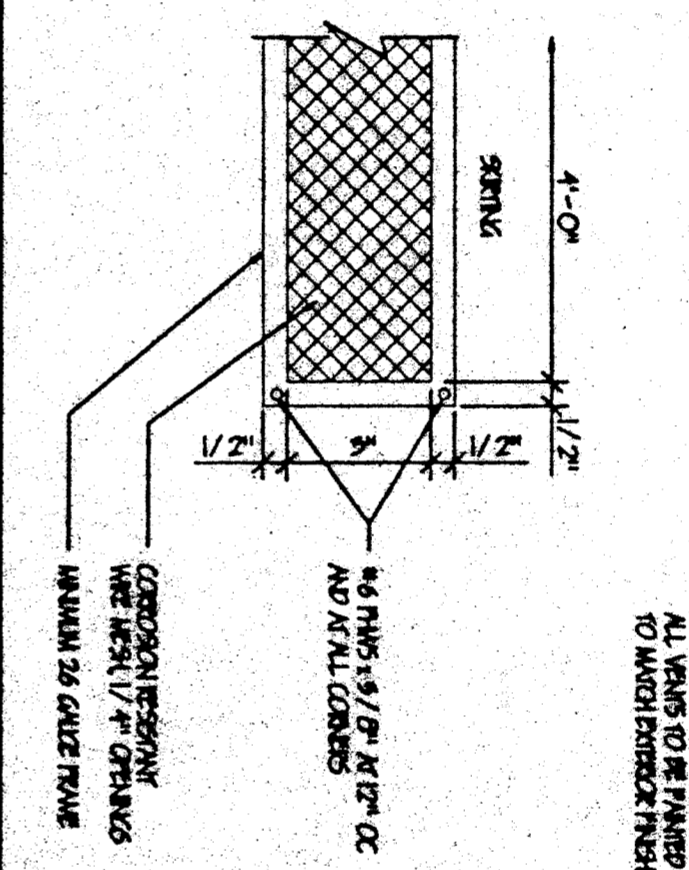
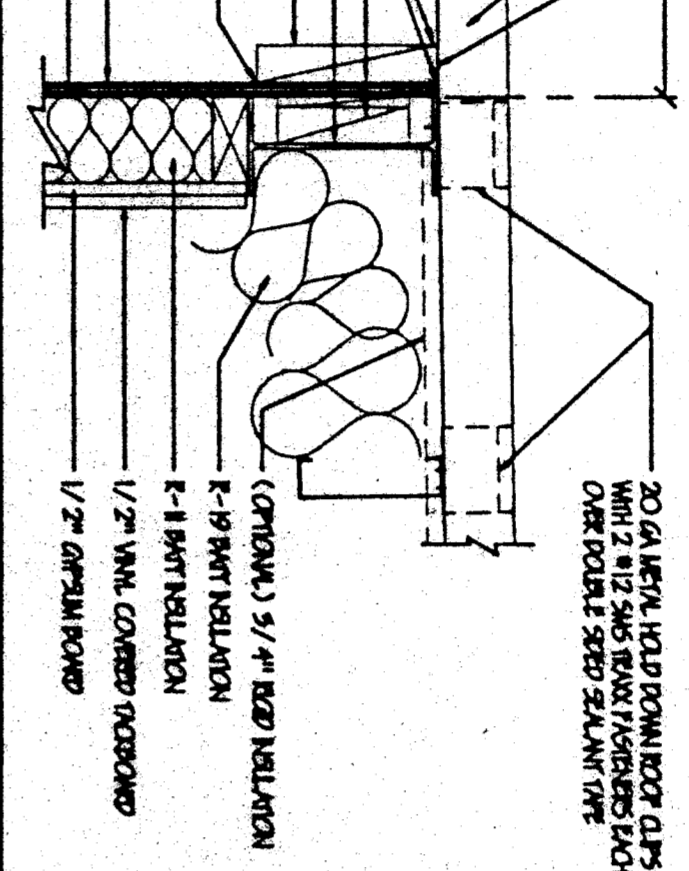
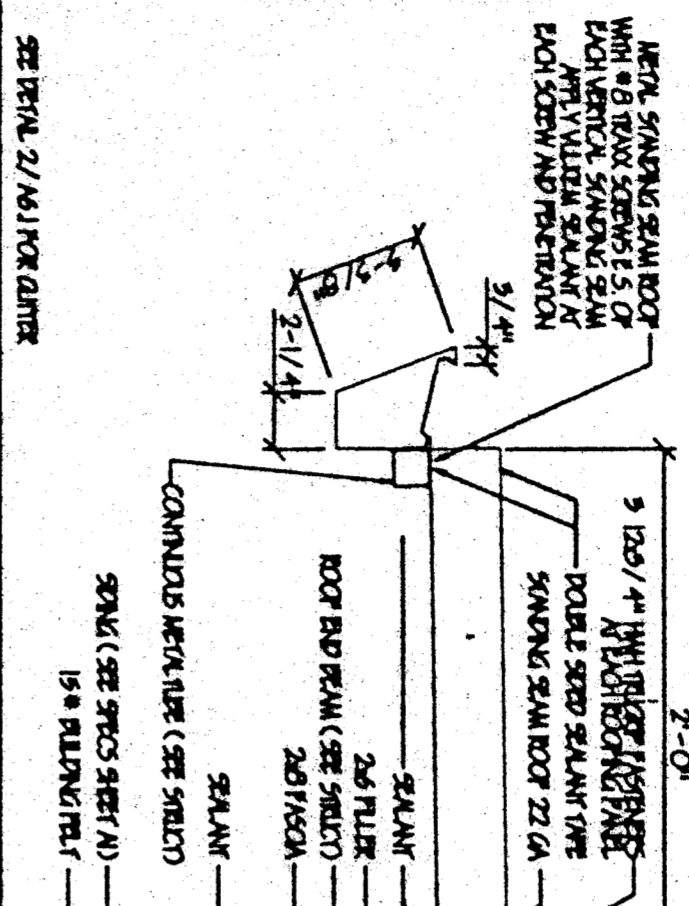
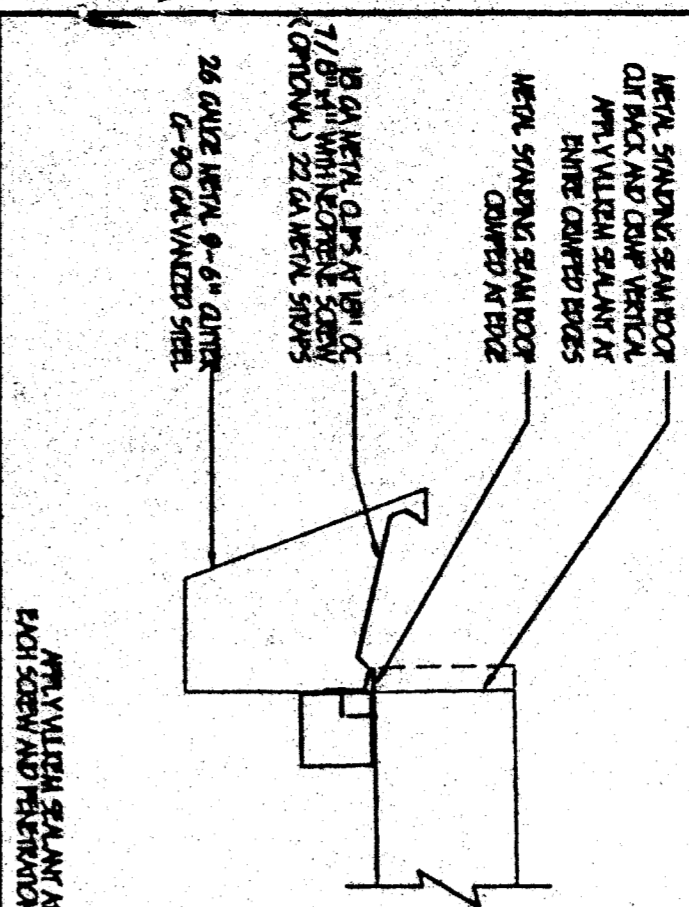

2 QUILTER
SCALE: 1/4"=1'-0"

7 REAR OVERHANG
SCALE: 1/4"=1'-0"

15 VENT
SCALE: 1/4"=1'-0"

16 INT. WALL FINISH
SCALE: 1/4"=1'-0"

20 INT. DOOR JAMB
SCALE: 1/4"=1'-0"

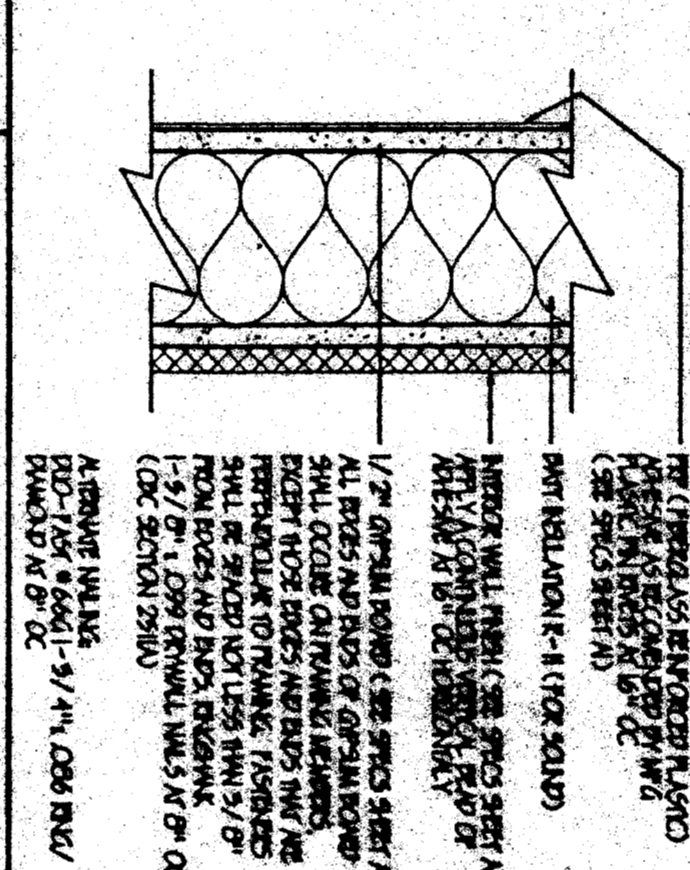
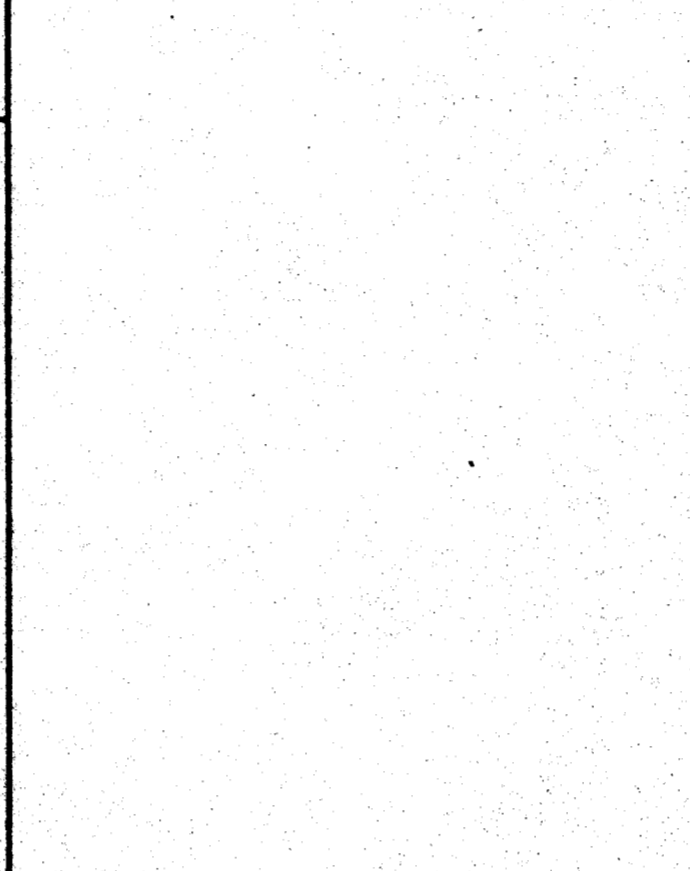
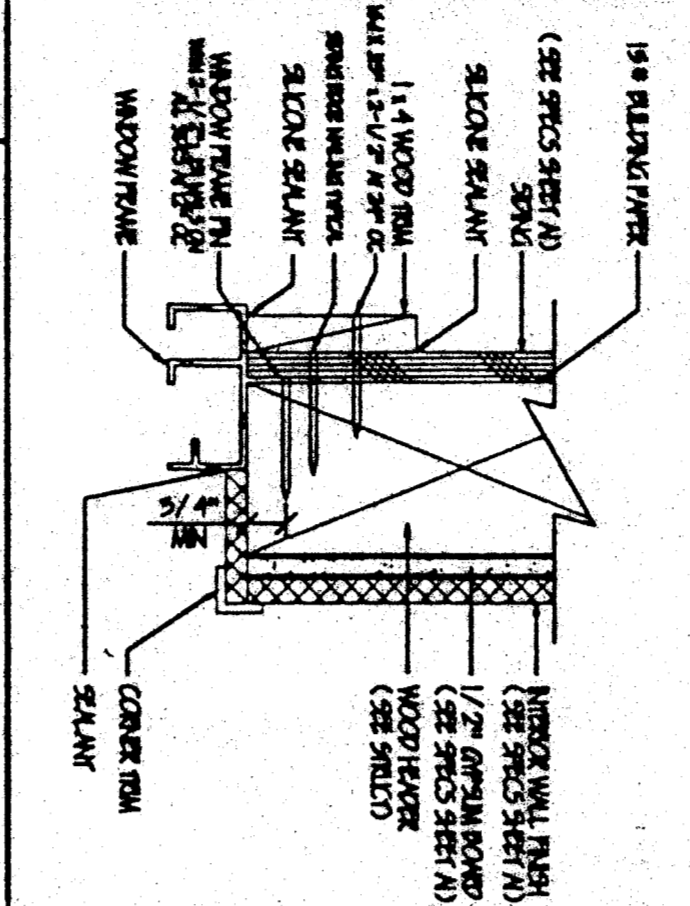
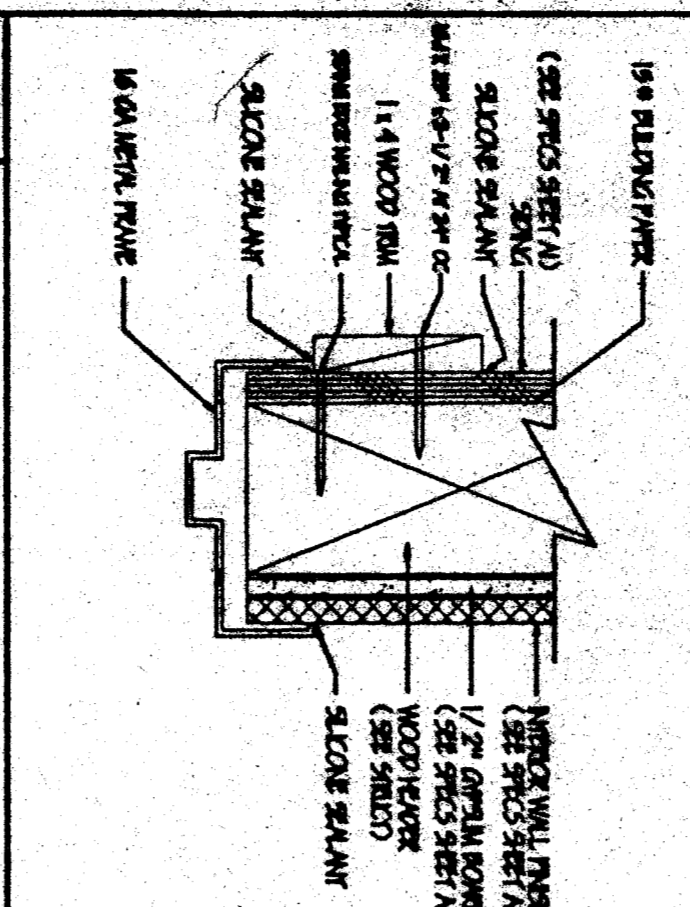

3 DOOR HEAD
SCALE: 1/4"=1'-0"

8 WINDOW HEAD
SCALE: 1/4"=1'-0"

17 MOD. CLOSURE
SCALE: 1/4"=1'-0"

21 DOOR THRESHOLD
SCALE: 1/4"=1'-0"

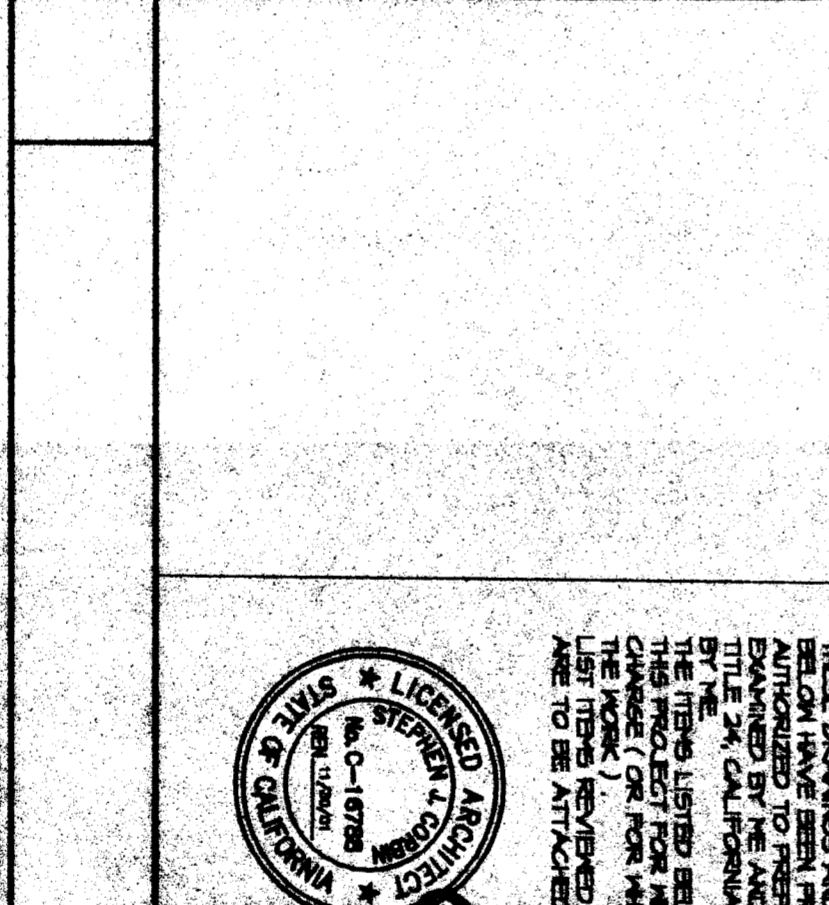
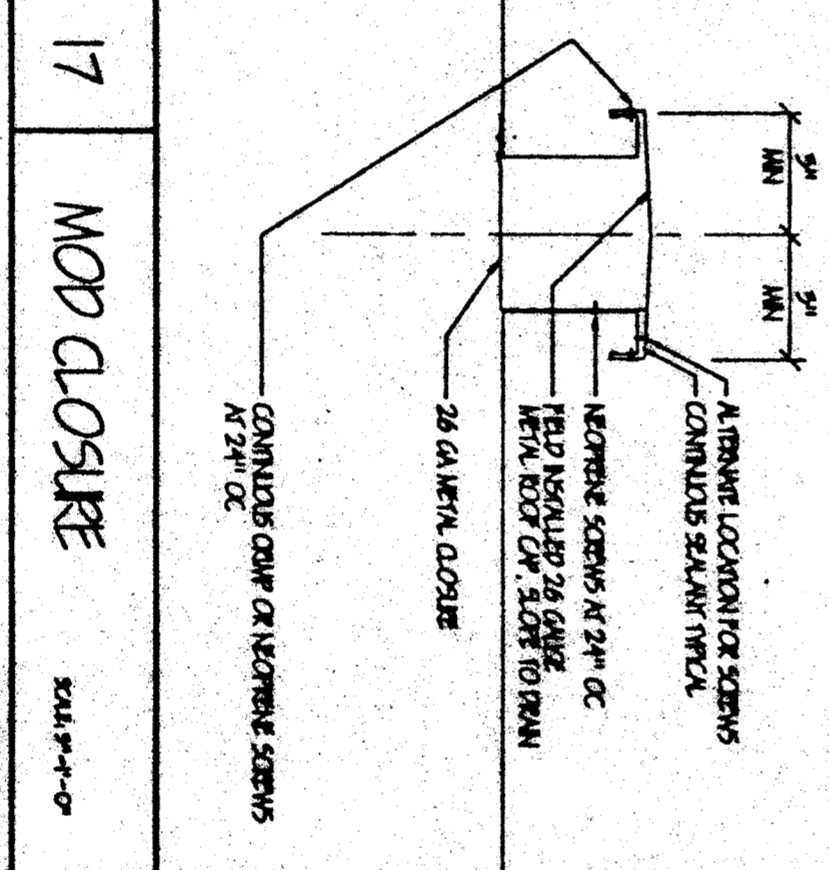
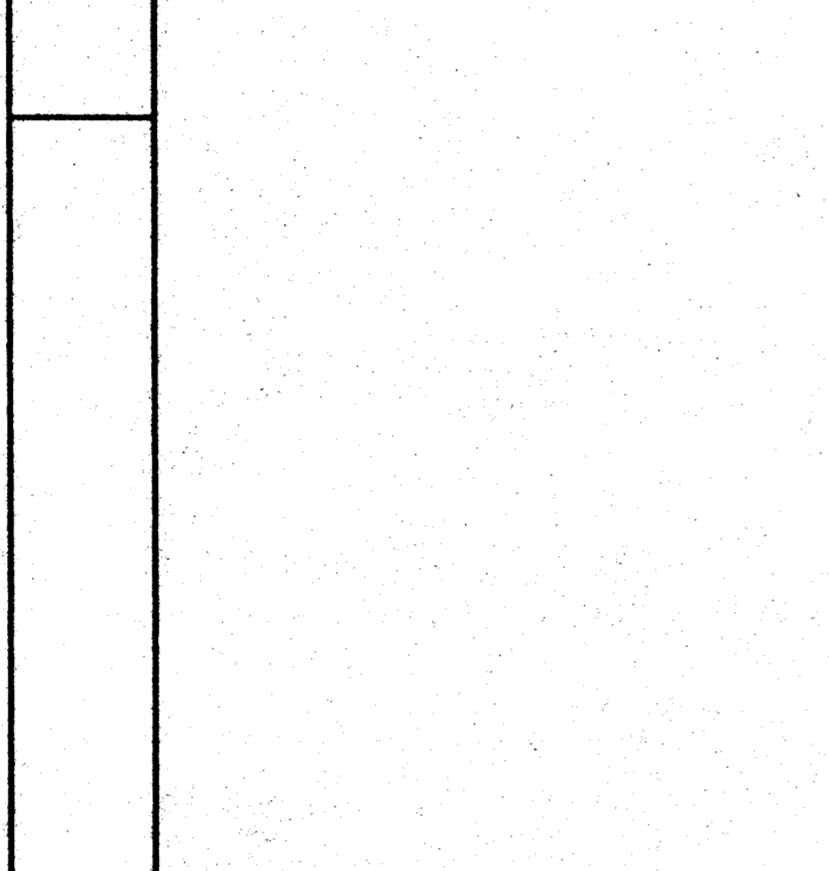
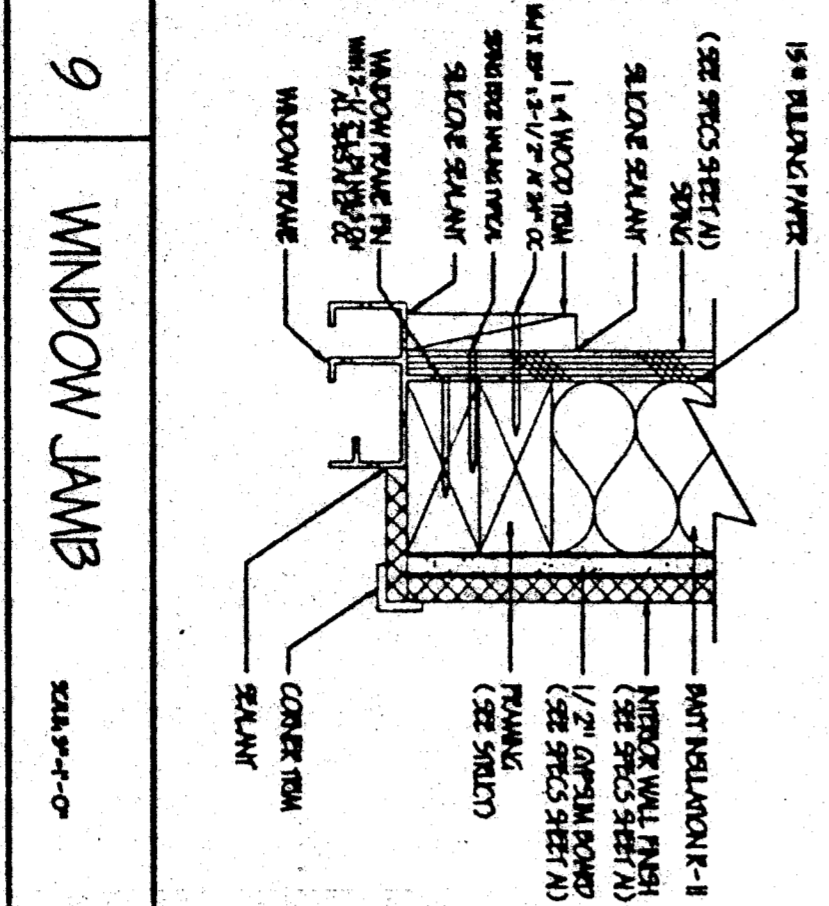
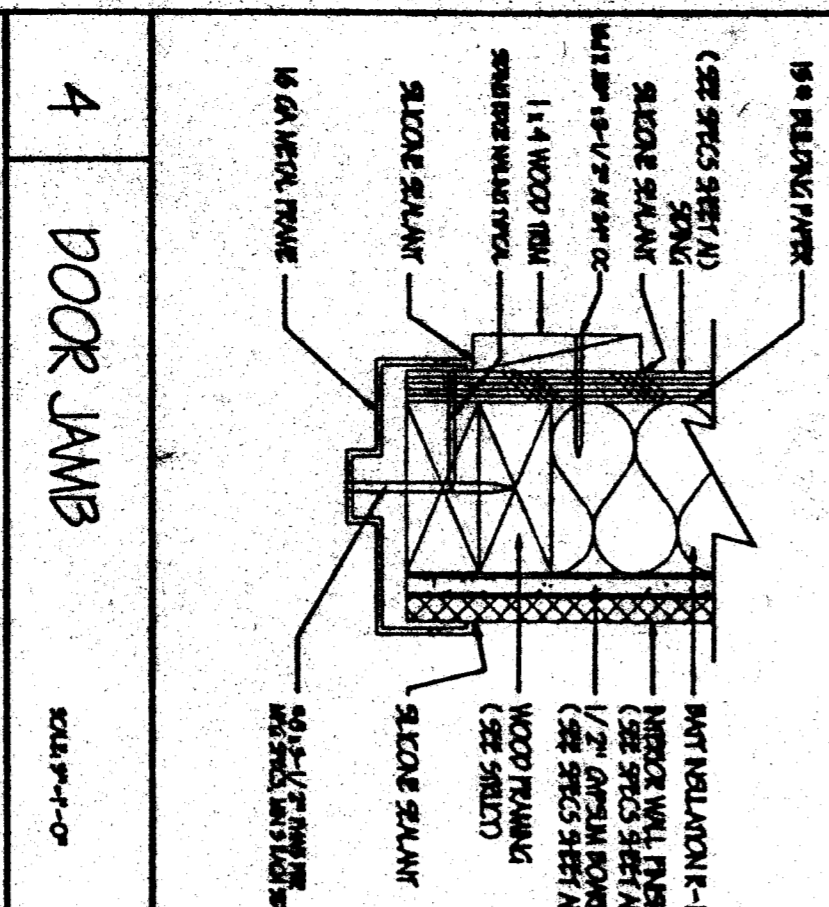

4 DOOR JAMB
SCALE: 1/4"=1'-0"

9 WINDOW JAMB
SCALE: 1/4"=1'-0"

14 WALL FINISH
SCALE: 1/4"=1'-0"

18 ROOF CLIP
SCALE: 1/4"=1'-0"

23 ALT. ROOF CLIP
SCALE: 1/4"=1'-0"

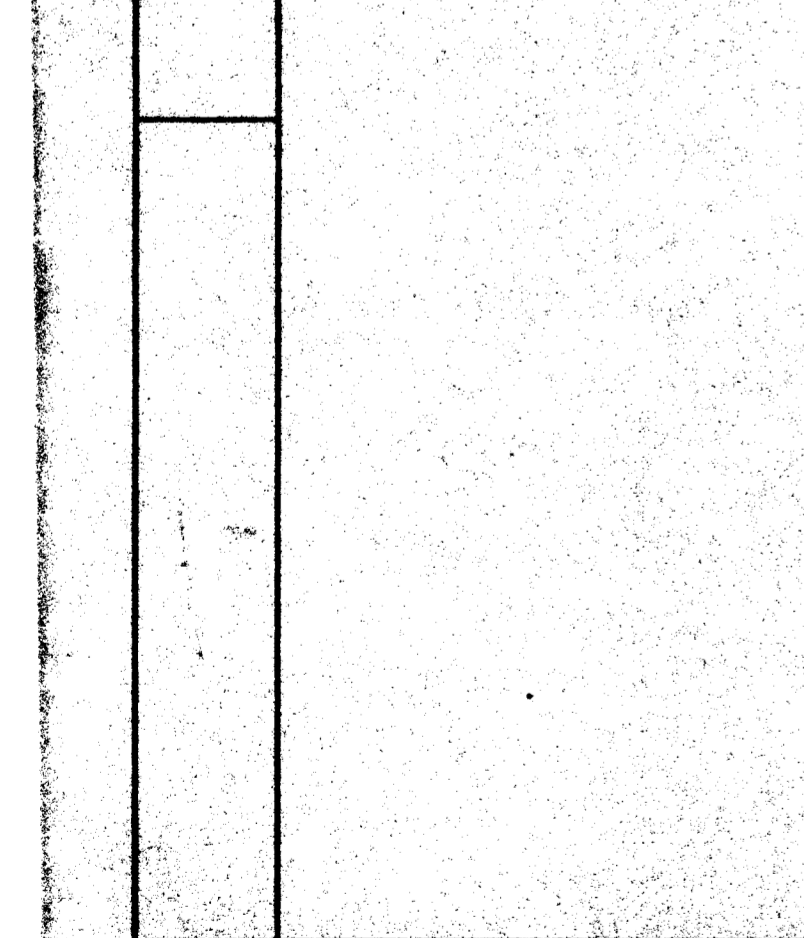
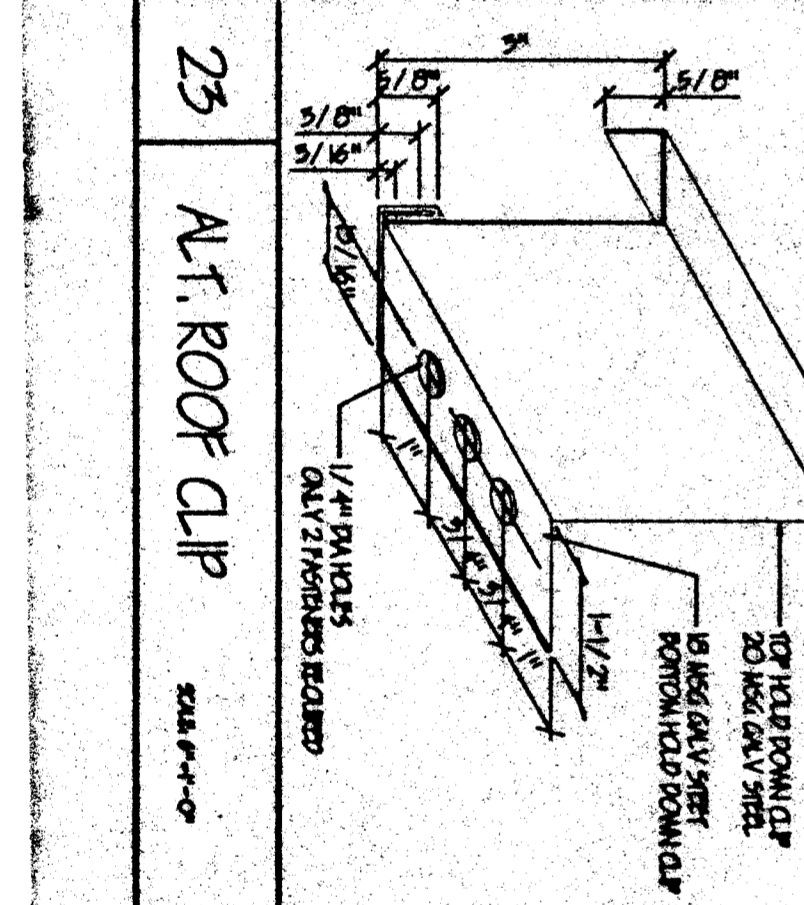
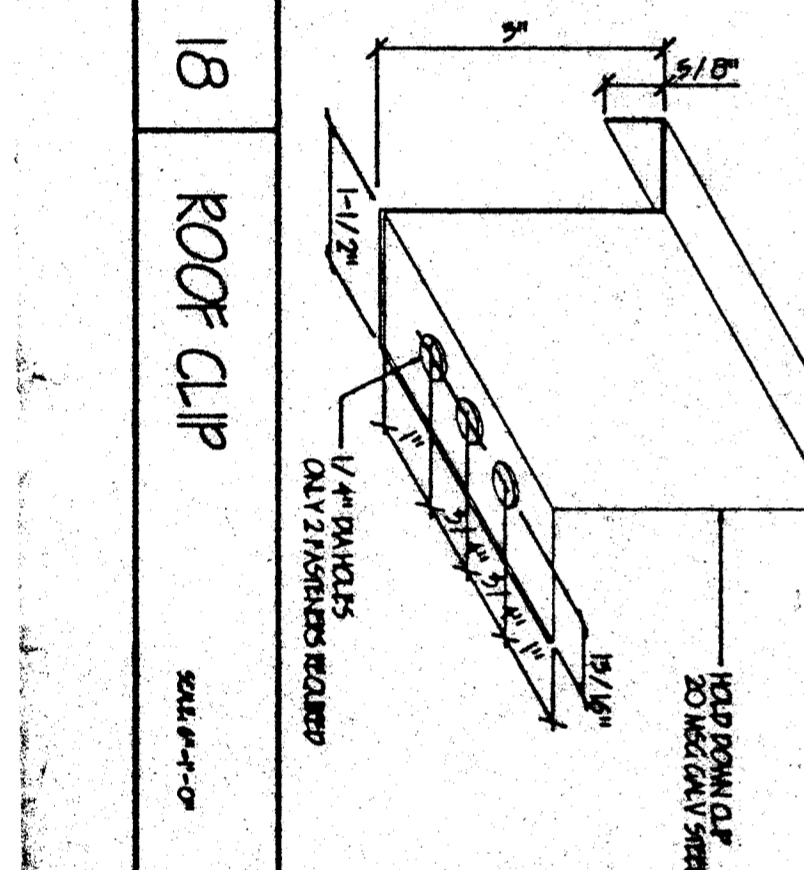
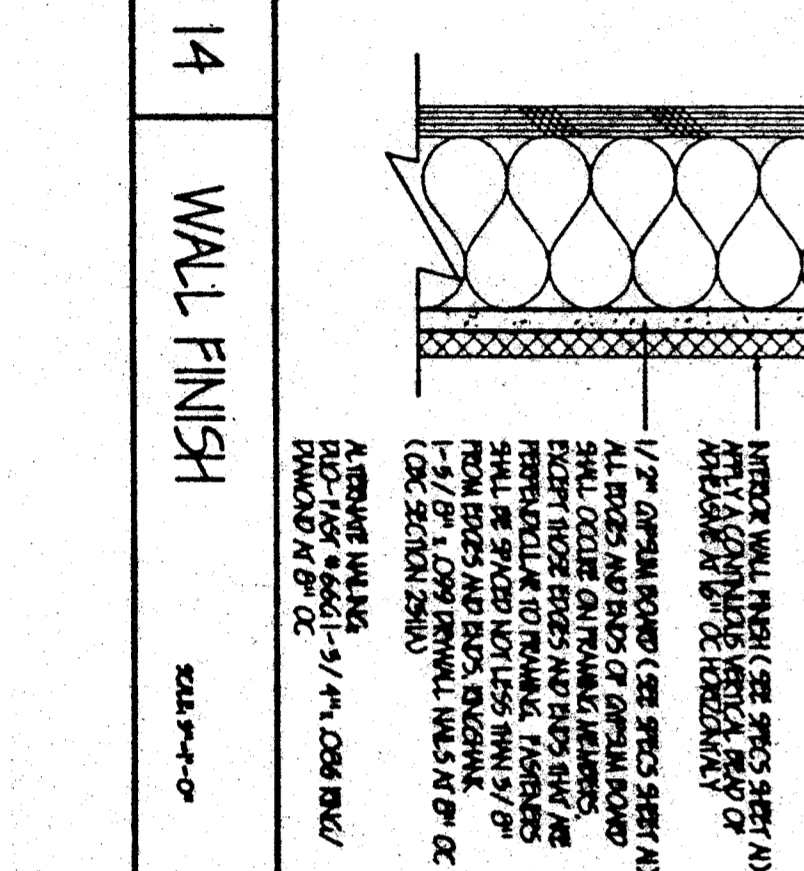
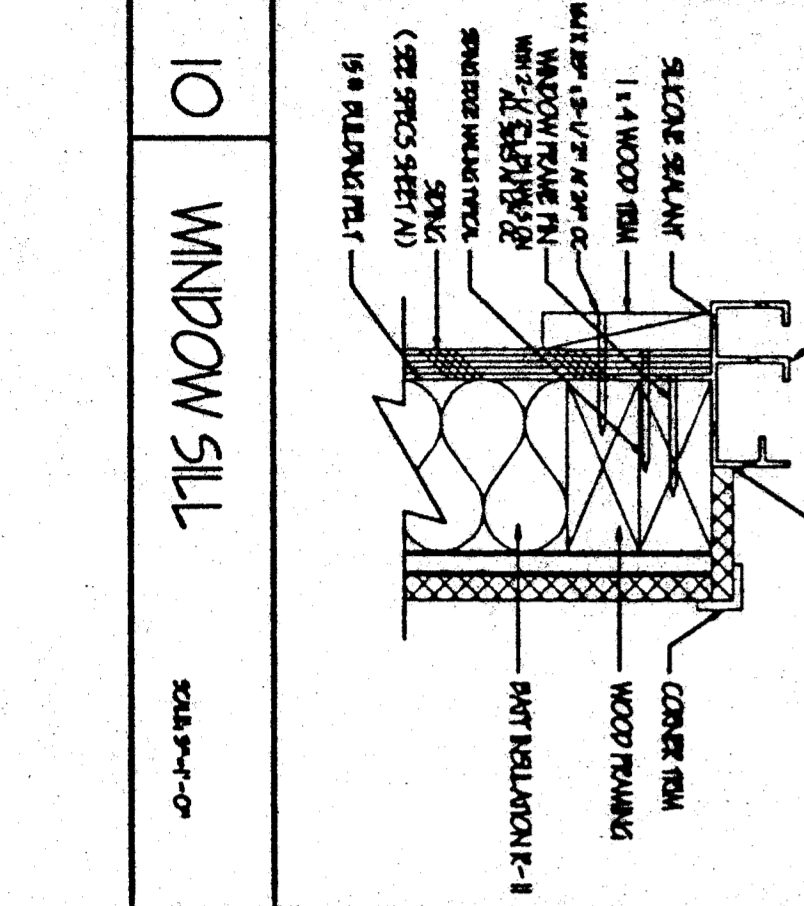
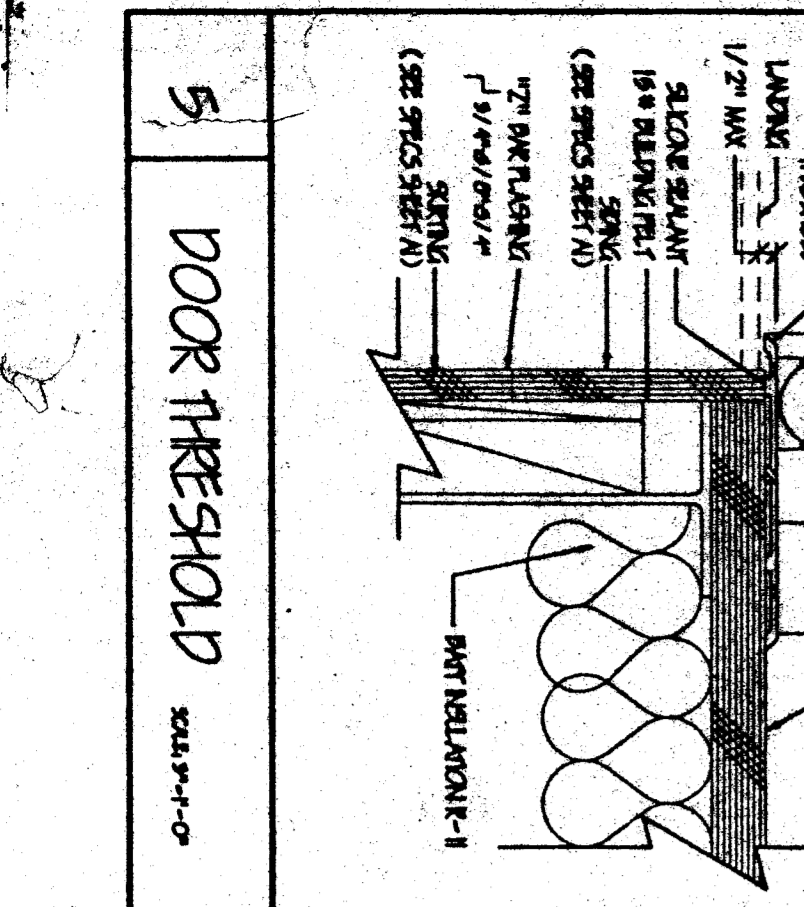

5 DOOR THRESHOLD
SCALE: 1/4"=1'-0"

10 WINDOW SILL
SCALE: 1/4"=1'-0"

GENERAL NOTES
ALL NOTES SHALL GOVERN OVER ANY CONFLICTING NOTES ON OTHER DRAWINGS.

LEGEND
 - - - - - PART RELIEF (OPTIONAL)
 - - - - - WOOD MEMBER
 - - - - - METAL MEMBER
 - - - - - INSULATION
 - - - - - FINISH

APPROVALS
 ARCHITECT: [Signature]
 ENGINEER: [Signature]
 CONTRACTOR: [Signature]

REVISIONS
 NO. DATE BY
 1 11/20/97 [Signature]
 2 11/20/97 [Signature]
 3 11/20/97 [Signature]
 4 11/20/97 [Signature]
 5 11/20/97 [Signature]

NORMAN A. GEIGER
 P.O. BOX 41064
 SACRAMENTO, CA 95841
 (916) 382-2453 FAX
 (916) 382-2453 PHONE

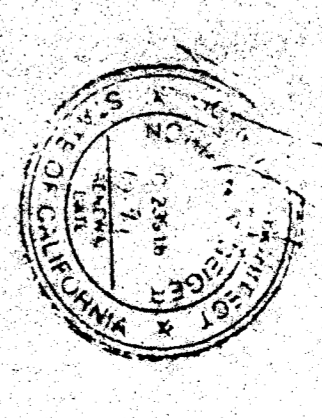

PACESETTER INDUSTRIES, INC.
 P.O. BOX 1131, MODESTO, CA 95353 (209) 521-1600

24x40 RELOCATABLE BUILDING
 SHEET A6.1
 DATE: 11/20/97
 DRAWING SCALE: AS SHOWN
 PROJECT NUMBER: 97-03